



Multi V™ IV and 5 Control System Install Tips

The following pages present an overview of Multi V Variable Refrigerant Flow (VRF) Control installation concepts, and are intended to supplement the technical and installation information provided with each product and through www.lg-vrf.com. The review of basic installation and configuration information should provide helpful tips to make equipment control successful.

Note:

⊘ *The installation guide is NOT intended to be a replacement for LG installation manuals, nor is it intended to cover ALL the possible options for control of, or related to, VRF systems. For detailed information on the procedures mentioned herein, refer to the installation manual specific to your product. Always comply with applicable local, state, and federal codes.*

Safety Instructions - Wiring

⚠ DANGER

High voltage electricity is required to operate this system. Adhere to the U.S. National Electric Code (NEC) and these instructions when wiring. *Improper connections and inadequate grounding can cause accidental injury or death.*

⚠ WARNING

The information contained in this manual is intended for use by an industry-qualified, experienced, trained electrician familiar with the NEC who is equipped with the proper tools and test instruments. *Failure to carefully read and follow all instructions in this manual can result in personal injury or death.*

Refer to local, state, and federal codes, and use power wires of sufficient current capacity and rating. *Wires that are too small may generate heat and cause a fire, resulting in physical injury or death..*

All electric work must be performed by a licensed electrician and conform to local building codes or, in the absence of local codes, with the NEC, and the instructions given in this manual. *If the power source capacity is inadequate or the electric work is not performed properly, it may result in fire, electric shock, physical injury or death.*

Note:

The information contained in this manual is intended for use by an industry-qualified, experienced, trained electrician familiar with the NEC who is equipped with the proper tools and test instruments. *Failure to carefully read and follow all instructions in this manual can result in equipment malfunction and / or property damage.*

Always ground the unit following local, state, and NEC codes. There is risk of fire, electric shock, and physical injury or death.

Properly size all circuit breakers or fuses. *There is risk of fire, electric shock, explosion, physical injury or death.*

Secure all field wiring connections with appropriate wire strain relief. *Improperly securing wires will create undue stress on equipment power lugs. Inadequate connections may generate heat, cause fire, physical injury, or death.*

⊘ Do not change the settings of the protection devices. *If the pressure switch, thermal switch, or other protection devices are bypassed or forced to work improperly, or parts other than those specified by LG are used, there is risk of fire, electric shock, explosion, and physical injury or death.*

Properly tighten all power lugs. *Loose wiring may overheat at connection points, causing a fire, physical injury or death.*

⊘ Do not supply power to the unit until all electrical wiring, controls wiring, piping, installation, and refrigerant system evacuation are completed.

Tools

Verify the tools listed below are available for use at the installation site:

- Screw Drivers (JIS for terminal screws, Flat, Phillips)
- Wire Strippers, Cutters, and Crimpers
- Hole Saw
- Pliers
- Adjustable Wrenches
- Digital Multi-meter and Amp Clamp
- Drill and Bits

Wiring

⚠ WARNING

- *All power wiring and communication cable installation must be performed by trained service providers working in accordance with local, state, and NEC regulations.*
- *Install appropriately sized breakers / fuses / overcurrent protection switches and wiring in accordance with local, state, and NEC regulations. Using inappropriately sized electrical components may result in electric shock, physical injury, or death.*
- *Properly ground all outdoor units and indoor units. ⊘ Do NOT connect ground wire to refrigerant, gas, or water piping; to lightning rods; to telephone ground wiring; or to the building plumbing system. Failure to properly provide an NEC approved earth ground can result in electric shock, physical injury or death.*
- *Properly terminate all wiring. If wires are not properly terminated and attached, there is risk of fire, electric shock, and physical injury or death.*

Power Wiring Specifications

Outdoor unit(s) and indoor units must be provided power from separate breakers. Each outdoor unit frame in a multi-frame configuration must be provided a dedicated fused disconnect or breaker. Heat pump and heat recovery outdoor units are available in both 3Ø, 208-230V, 60Hz (acceptable operating voltage: 187 – 253V), and 3Ø, 460V, 60Hz (acceptable operating voltage: 414 – 528V). Power imbalance between phases cannot be greater than 2%. Power wiring to the outdoor unit(s) must comply with all local codes, as well as the NEC. Position the power wiring a minimum of two (2) inches away from the communication cables to avoid potential operation problems caused by electrical interference. ⊘ Do not run both in the same conduit.

Indoor units and heat recovery units require 1Ø, 208-230V, 60Hz power, but each unit draws minimal power. Where permitted by NEC and local codes, multiple indoor units and heat recovery units may be powered from a single breaker. Service switches typically must be installed for each indoor unit and heat recovery unit.

Communication Cable Specifications

- Communications cable from Outdoor Unit(s) to Indoor Units and Heat Recovery Units must be 18 gauge, two-conductor, twisted, stranded, shielded. Ensure the communication cable shield is properly grounded to the Outdoor Unit chassis only (Master Outdoor Unit, if dual / triple chassis system).
 - Indoor Unit / Heat Recovery Unit communication. bus: Outdoor Unit IDU A and B terminals to Indoor Units A / B, 3[A] / 4[B], or 3 / 4 terminals; for Heat Recovery units A / B terminals.
- Communications cable from the Master Outdoor Unit to the Slave Outdoor Unit(s) must be 18 gauge, two-conductor, twisted, stranded, shielded. Ensure the communication cable shield is properly grounded to the Master Outdoor Unit only.
 - Master / Slave communication bus: (S)ODU A and B terminals on Master Outdoor Unit to (S)ODU A and B terminals on Slave Outdoor Unit(s). (SODU = Multi V IV Outdoor Unit terminal labels; ODU = Multi V 5 Outdoor Unit terminal labels.)
- Communication cable from (Master) Outdoor Unit to Central Controllers must be 18 gauge, two-conductor, twisted, stranded, shielded wire.
 - Central control communication bus: CEN A and B terminals on (Master) Outdoor Unit to CH1, CH2, CH3, or CH4 terminals A and B on Central Controllers. (Some channels are not available on some controllers, see specific central controller install manual for correct channel to be used.)
- Communication cable from Outdoor Unit(s) to AC EZ Central Controllers must be (2) 18 gauge, two-conductor, twisted, stranded, shielded wire, or (1) 18 gauge, four-conductor, twisted, stranded, shielded wire.
- Communication cable from Outdoor Unit(s) to BMS / Gateways must be 18 gauge, two-conductor, twisted, stranded, shielded wire. (PDI requires connection to field-supplied watt-meter.)
- Communication cable from Indoor Units to Wired Remote Controllers is a 33' connection cable (included with the Wired Remote Controllers), or if terminals, are present 22 gauge, three-conductor, twisted, stranded, unshielded wire.
 - Wired Remote Controller communication bus: GND - SIG - 12V terminals on Indoor Unit to GND - SIG - 12V terminals on Wired Remote Controller.
- Communication Cable from Outdoor Unit to Heat / Cool Selector switch must be 18 gauge, three-conductor, twisted or non-twisted, stranded, shielded.

Wiring Connections

LG uses a "JIS" type of screw for all terminals; use a JIS screwdriver to tighten and loosen these screws and avoid damaging the terminal. Use a solderless ring or fork connection when possible. ⚠ Do not overtighten the connections — overtightening may damage the terminals — but firmly and securely attach the wiring in a way to prevent external forces from being imparted on the terminal block.

Note:

- **The terminals labeled "GND" are NOT ground terminals. The terminals labeled \oplus ARE ground terminals.**
- **Polarity matters. Always connect "A" to "A" and "B" to "B."**
- **Always create a wiring diagram that contains the exact sequence in which all the indoor units and heat recovery units are wired in relation to the outdoor unit.**
- ⚠ **Do not include splices or wire nuts in the communication cable.**

JIS Screws.

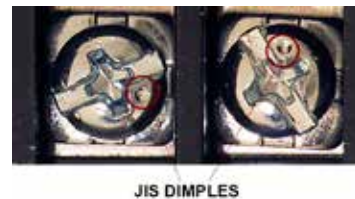

Addressing

Auto Addressing

Multi V systems include an automatic process - auto addressing - that has to be completed for the system to function as a whole. In auto addressing, the (master) outdoor unit sends out a communications signal to each indoor unit and heat recovery unit. Addressing enables the (master) outdoor unit to identify which indoor unit and heat recovery unit the data is coming from and going to. Before initiating the auto addressing procedure, verify that the compressors are disabled.

Auto Addressing Procedure

- Supply power to each indoor unit and heat recovery unit - if applicable - but do not turn the power buttons on.
- Turn power to the (master) outdoor unit on. After three (3) full minutes, the outdoor unit display should be blank.
- Press and hold the RED button on the Main PCB for three (3) to four (4) seconds. Release the RED button when the display changes to "88."
- After about three (3) to seven (7) minutes, the display will flash the number of indoor units found, and then the number of heat recovery units found (if applicable).
- Wired remote controllers and indoor LEDs will indicate the auto address numbers assigned to them by the outdoor unit.
- If all indoor units and heat recovery units are found and no errors codes have appeared, then auto addressing was successful.
- If all indoor units and heat recovery units are not found and / or errors codes have appeared, check:
 - The circuits on all indoor units and heat recovery units are on.
 - The indoor unit communications cable daisy chain for improper connections.

Central Controller Addressing

If the Multi V system includes a Central Controller / BMS Gateway, the installer must manually set (through the remote controller) each indoor unit with a two-character hexadecimal address: 0-9 and A-F (⚠ but do not use Address "00"). This allows the indoor units to be recognized by the central controller / BMS gateway. Write up an addressing schedule before initiating the procedure. Power the indoor unit on to address, then power off when complete.

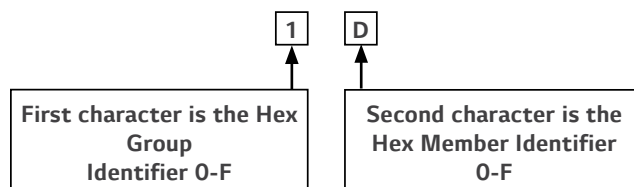

Switch and Dial Settings

DIP Switches and Rotary Dial Settings

Installer may need to manually set DIP switches and rotary dials because of installation or application requirements. See next page for an overview of the most common settings. Power must be cycled after changing the switch settings.

Outdoor Units - DIP Switches

In a dual / triple frame system, one (1) outdoor unit must be set to master and the others set to slave(s) or an error code will be generated. For DIP-SW01 bank on the master unit, all DIP switches must be set to off. On slave 1, set only DIP switch 6 to ON. On slave 2, set only DIP switch 7 to on.

Example of Multi V 5 Outdoor Unit DIP Switches and Location.

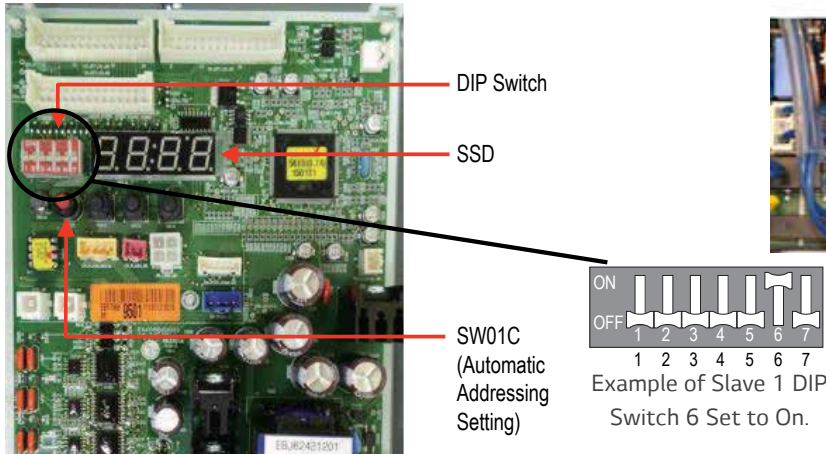

Indoor Units - DIP Switches

Installer may need to adjust DIP switches on some types of indoor units if the project calls for certain functions. See the Engineering and Installation Manuals at www.lg-vrf.com for information on specific indoor units.

Example of Indoor Unit DIP Switches and Location.



Specific Multi V 5 Outdoor Unit DIP Switch Settings

Setting Multi V 5 Outdoor Units to a Heat Pump or Heat Recovery System

Outdoor units are factory set to heat recovery operation—all switches on DIP Switch bank SW01 are set to OFF. All outdoor unit(s) (master and slave[s]) MUST be manually set to a heat pump system. To change the factory-set heat recovery system to a heat pump system:

- Flip switch No. 4 on the DIP-SW01 bank to ON. Display will show "HR" (heat recovery).
- Push the (SW03C) button to change "HR" (heat recovery) to "HP" (heat pump), then press the confirm (SW01C) button.
- Flip switch No. 4 on the DIP-SW01 bank to OFF, and push the reset (SW01D) button to restart the system. If No. 4 on the DIP-SW01 bank is switched to ON again, "HR" (heat recovery) or "HP" (heat pump) can be verified by reading the display later.

Heat Recovery System DIP Switch Setting on Outdoor Units (Factory Set).

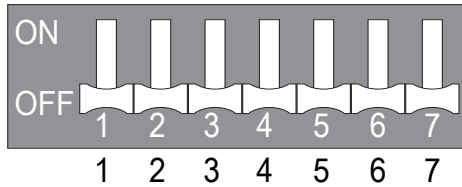

Heat Pump System DIP Switch Setting on Outdoor Units (Manually Set).

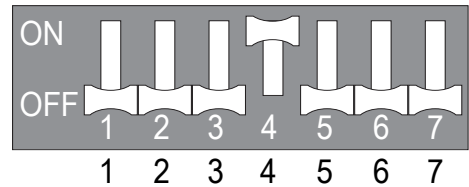

Multi V 5 Heat Pump System Piping

When the system is manually configured as a heat pump the **Hot Gas** line is used as the Suction (Vapor) Pipe.

⊘ **Do not connect any piping to the Suction (Largest) Pipe.**

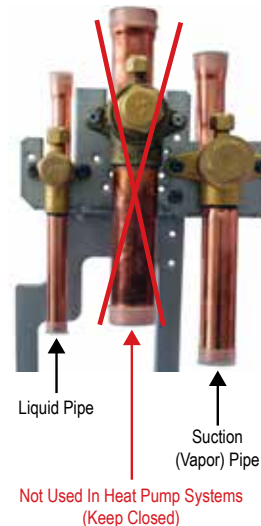

DIP Switch Settings for Use with Gen 4 Indoor Units

LG “Generation 4” Indoor Units (Gen 4)

All indoor units are either Gen 2 or Gen 4. Gen 3 does not exist. Gen 4 equipment first shipped to the U.S. in July 2016. For Gen 4 indoor units to operate with Gen 4 indoor unit features, the air conditioning system must meet the following requirements:

- All indoor units, heat recovery units, and air / water source units must be Gen 4 or higher.
- All air / water source units must have Gen 4 or higher software installed.
- Air / water source units DIP switch 3 must be set to ON (factory default setting is OFF).
- All controllers must support Gen 4 indoor unit features.

The figure at right shows the outdoor unit DIP switch. The “System Component Combinations and Operation Status” table lists how combining different components will affect system operation. The “Serial Numbers or Air / Water Source Units with Gen 4 or Higher Software” table lists the serial numbers of air and water source units that have Gen 4 or higher software. All air and water source units, indoor units, heat recovery units, and controllers in a system must be Gen 4 compatible or the system will not operate with Gen 4 indoor unit features.

Location and Setting of Outdoor Unit DIP Switch 3. Air IV / Water Source IV Unit DIP Switch No. 3.

Air/Water Source Unit DIP Switch No. 3

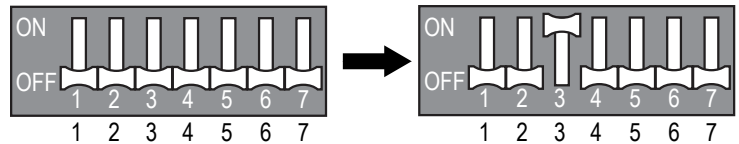
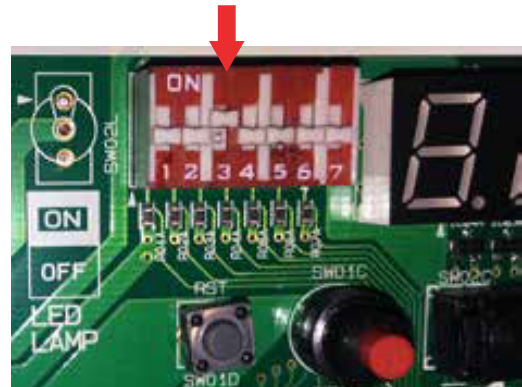

System Component Combinations and Operation Status.

Air/Water Source Units*	Indoor Unit(s)**	Heat Recovery Unit(s)	Outdoor Unit DIP Switch No. 3	Operation Status
Gen 4 or Higher	Gen 4 ONLY	Model 2A ONLY	Must be ON	System will operate WITH Gen. 4 indoor unit features.
Gen 4 or Higher	Gen 4 ONLY	Model 2A ONLY	OFF	System will operate WITHOUT Gen. 4 indoor unit features.
Gen 4 or Higher	Gen 4 ONLY	Any combination of Models 1A, 2A	Must be OFF (factory default)	Does NOT include Gen. 4 features. System will not operate if DIP Switch No. 3 is ON, and an error code will be generated.
Gen 4 or Higher	Any combination of Gen 2 and Gen 4	Model 2A ONLY	Must be OFF (factory default)	
Gen 4 or Higher	Any combination of Gen 2 and Gen 4	Any combination of Models 1A, 2A	Must be OFF (factory default)	
Gen 2	Any combination of Gen 2 and Gen 4	Any combination of Models 0A***, 1A, 2A	N/A***	Does not include Gen. 4 features.

*Gen 4 Air / Water Source Units

Multi V 5, late production Multi V IV, late production Multi V Water IV, and Multi V S.

Gen 2 Air / Water Source Units

Multi V II, Multi V III, early production Multi V IV, Multi V Water II, early production Multi V Water IV, Multi V Mini, Multi V Water Mini, and Multi V Space II.

**DIP Switch No. 3 on Gen 2 air / water source units is not related to Gen 4 features as it is with Gen 4 air / water source units.

***0A Model Heat Recovery units are not for use with Multi V 5, Multi V IV, Multi V Water IV, or Multi V III heat recovery systems.

Serial Numbers of Air / Water Source Units with Gen 4 or Higher Software.

Air / Water Source Unit Model Type	Multi V Air Source Heat Pump	Multi V Air Source Heat Recovery	Multi V IV Water Source Heat Pump	Multi V IV Water Source Heat Recovery
Serial Number Sequence of Gen 4 units	502***** and Higher	503***** and Higher	504***** and Higher	

Gen 4 Indoor Units model numbers end in “4”; Gen 2 Indoor Units model numbers end in “2” or an “A”, including Hydro Kit.

Central Control Configuration

The following page present an overview of Multi V Variable Refrigerant Flow (VRF) Central Control Configuration concepts, and are intended to supplement the technical and installation information provided with each product and through www.lg-vrf.com. For specific configuration details please consult the installation and owner manuals for the Central Controller in question.

Installation

To use an LG Central Controller, build an environment for it with devices like indoor units, ERV, DI/DO, DOKIT, AWHP, AHU and I/O Module. Use the Central Controller to register those devices. Central Controllers should be installed in the following order:

Step 1.

Make sure the system is running without error under local control. Run the system under local control in all modes to make sure it runs without error and functions as expected.

Step 2.

Make sure that each device has been assigned a unique central control address. Manually set (through the remote controller) each indoor unit with a two-character hexadecimal address: 0-9 and A-F (⊗) but do not use Address "00".

Central Control Network Example

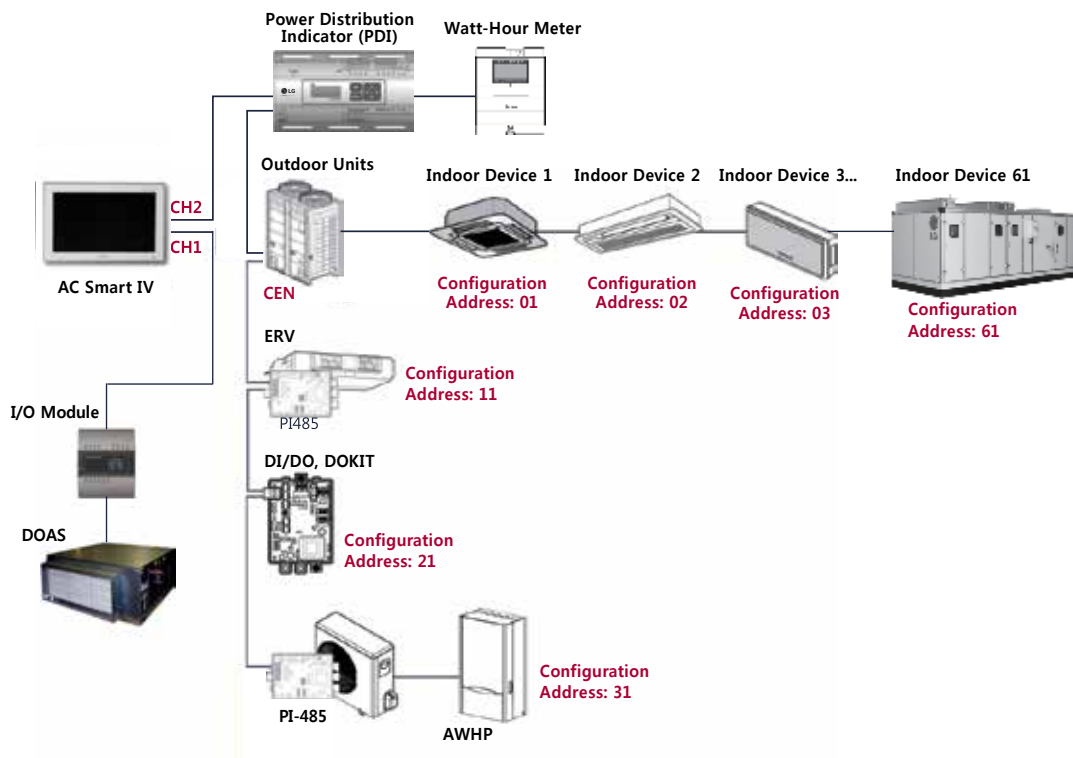

Step 3.

Connect V-Net devices with Central Controller. Check that the appropriate wire has been used (See install manual of each device) to connect V-Net devices with the Central Controller.

Step 4.

Login and register all devices. Login to the Central Controller and register all devices that have a central control address.

Default Access

- Launch a browser
- Enter the IP address of the central controller in the address bar.
- Default access is always the same:
 - Default IP: 192.168.1.101
 - Default user: system_admin
 - Default Pass: digital21



Login

ID

Passwd

save ID

Heat Recovery Units - Rotary Switch

Every heat recovery unit on each system must be addressed with a unique character (0-F) set by SW05M rotary switch on its PCB. Start with 0 (assign 0 to the heat recovery unit that has the largest capacity indoor unit connected to port number one [1]), and count up (1, 2, etc.) for additional heat recovery units.

Heat Recovery Units - DIP Switches

Heat recovery units are available in up to four ports, but depending on the application, not all ports have to be used (unused ports must be capped off). Switches 2 and 3 on SW02M DIP switch bank are used to designate how many ports are being used.

- Large capacity (6 and 8 ton) indoor units require two ports on a heat recovery unit that are twinned together with a Y-branch kit. Switches 4, 5, and 6 on SW02M DIP switch bank identify which ports are being used for this application (valve group setting).
- Heat recovery units can support up to eight (8) indoor units on one port (zone setting for auto pipe detection). The installer must apply settings to two different DIP switch banks for this system design to function properly:
- SW01M DIP switch bank settings will tell the heat recovery unit there are multiple indoor units on specific ports.
- Switches 7 and 8 on SW02M DIP switch bank tells the heat recovery unit there is a zoned system piping configuration on its ports.

Location of Heat Recovery Unit DIP and Rotary Switches.

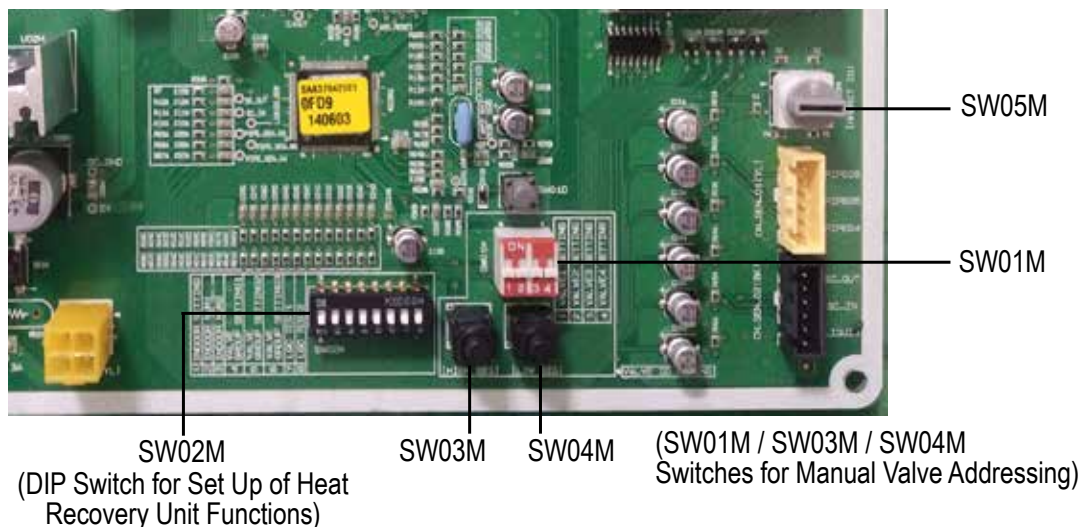

Other Field Set Up Options

- Installing and setting all wired remote controllers. Access the field installer settings to display functions (information displayed depends on product features).
- Choose and set the controlling room temperature sensors.
- Airflow for ducted indoor units many need to be adjusted to deliver the require airflow at the external static pressure of the duct system. If the project calls for group control of indoor units:
 - For systems without central control, turn power off at all indoor units designed as a group. Determine which indoor unit is master, then, using optional group control kits, connect subsequent slave indoor units.
 - For systems with central control, address the master unit and turn DIP switch No. 3 to on for all slave indoor units. Use a wireless remote to set wall mounted indoor units to slave.

Pre-Commissioning Summary

By this point, the following procedures should be complete:

- Triple Leak / Pressure Test and Triple Evacuation have been performed.
 - For the triple leak / pressure test, the piping system held ≤ 550 psig for a minimum of 24 hours (last step). See the outdoor unit installation manuals for a detailed triple leak / pressure test procedure.
 - For the triple evacuation test, the micron gauge must hold at ≤ 500 microns for a minimum of 24 hours (last step). See the outdoor unit installation manuals for a detailed triple evacuation procedure.
 - Any field-installed ball valves in the refrigerant system (if used) should be open to ensure all piping is free and clear for evacuation on all piping and connected indoor units / heat recovery units.
- The outdoor unit service valves must remain closed and the stem head access caps tight during the triple leak / pressure and triple evacuation procedures, and before commissioning. ⚠ Do not open the outdoor unit service valves and release the factory refrigerant charge until the LG trained commissioner authorizes you to do so. The system must be left in vacuum until the LG trained commissioner verifies the quality of the evacuation.
 - Auto Addressing has been successfully completed.
 - If the system includes a central controller / BMS gateway, applicable components have been assigned a two-character hexadecimal address.
 - All necessary DIP switches and rotary dials have been set properly.
 - All indoor units have been checked for power at the unit disconnect and power is present at the indoor unit PCB board. (LED is lit.) ⚠ Do not turn on the unit using the on / off button.
 - The communications cable to the indoor units has been disconnected from the IDU (B) and IDU (A) terminals at the outdoor unit(s).
 - Install checklist points have been followed, verified, and any needed corrections have been made.
 - Power has been energized to the outdoor unit(s) to power the compressor crankcase heater(s) at least six (6) hours before commissioning.

Prepare Pre-Commissioning Package Documents

Gather the following documents:

- Refrigerant piping system(s) shop drawing(s) generated by LATS Multi V pipe design software.
 - Pipe fitter's pipe changes and field notes.
 - Verified "As-Built" LATS Multi V Project file (*.mtv) that includes all changes noted by the pipe fitter(s). The tree diagram notes should include changes to the line lengths used for each liquid line segment. Verify that the sum of the indoor unit nominal capacity connected to the piping system is between 50% and 130% of the nominal capacity of the outdoor unit(s). If this rule is violated, the system will not start.
 - Air balance report showing proper airflow at all indoor units.
Completed and verified Installation Checklist for all the components in the system (see Installation Checklist, or see the Outdoor Unit Installation Manuals on www.lg-vrf.com). Correct any procedures needing attention before initiating a request for commissioning.
 - Completed Pre-Commissioning Device Configuration Worksheet with the models and serial numbers of all equipment to assist in full Warranty activation; completed Pre-Commissioning Checklist (see Outdoor Unit Installation Manuals at www.lg-vrf.com for copies).
 - If available, a list of IP addresses obtained from the building owners IT department for each ACP, BacNet®, LonWorks®, and AC Smart devices.*
- *BACnet is a trademark of ASHRAE; LonWorks is a trademark of Echelon Corporation.

The system should now be ready for commissioning procedures and additional trim charge. Send all Pre-Commissioning Package Documents to your LG Applied Representative and request commissioning assistance.

The contractor should ONLY request commissioning when everything is completed and all components tested / addressed (if a component is not operating within the usual parameters at the time of commissioning, then adjustments must be made that may prevent the Commissioner from signing off and approving the system). Before commissioning, the Commissioner may contact you to discuss specific job points, scheduled day(s) and expected duration. It is the contractor's responsibility to provide all of the necessary start-up labor, refrigerant, tools and test equipment needed to complete the process in the expected time frame.

⊙ Do not attempt to start the outdoor unit(s), charge refrigerant, or open service valves until directed by your Commissioner. After commissioning, the contractor will be notified if there are any corrections needed to allow warranty activation. The Distributor or LG Rep / Controls Contractor may provide assistance with controls setup, final device programming, BMS integration, air balance adjustments, etc.; and proceed with any owner training (if included).

Note:
Using LGMV monitoring software is encouraged for ease of future diagnostic and maintenance related checks.

Installation Checklist

Outdoor Unit Power Wiring

Description	Check										
Record power three phase 208-230V source or three phase 460V (verify system electrical requirements).											
<table style="width: 100%; border: none;"> <tr> <td style="width: 50%;">R (L1) to Ground -----</td> <td style="width: 50%;">R - S -----</td> </tr> <tr> <td>S (L2) to Ground -----</td> <td>R - T -----</td> </tr> <tr> <td>T (L3) to Ground -----</td> <td>S - T -----</td> </tr> <tr> <td></td> <td>Sum of the Above -----</td> </tr> <tr> <td></td> <td>Divided by 3 ----- = Average Voltage</td> </tr> </table>	R (L1) to Ground -----	R - S -----	S (L2) to Ground -----	R - T -----	T (L3) to Ground -----	S - T -----		Sum of the Above -----		Divided by 3 ----- = Average Voltage	
R (L1) to Ground -----	R - S -----										
S (L2) to Ground -----	R - T -----										
T (L3) to Ground -----	S - T -----										
	Sum of the Above -----										
	Divided by 3 ----- = Average Voltage										
Power wiring for each individual outdoor unit properly sized and protected per NEC and local codes for each individual outdoor unit.											
Ground wire was installed and properly grounded at each outdoor unit.											
The power supplied was clean with voltage fluctuations within specifications (187 – 253V for 208-230V units, 414 – 528V for 460V units).											
Power wiring for each individual outdoor unit was installed per all local, state, and NEC requirements.											
There are ring or fork terminals at all power wiring terminations.											

Indoor Unit / Heat Recovery Unit Power Wiring

Description	Check
Power provided is single phase, ±10% of indoor unit nameplate specifications.	
Power wires properly sized and protected per NEC and local codes.	
All indoor unit(s) are properly grounded.	
Terminal block screws are tight. Power wires are not in contact with terminals 3(A) and / or 4(B). Line voltage wires have ring or spade connectors installed.	
Power wires are properly secured to the control box case to prevent wire tension at the terminal block.	
Wires are protected from chaffing at control box and conduit pipe penetrations.	

Outdoor Unit to Outdoor Unit Communication Wiring

Description	Check
Communications cable from master outdoor unit to slave outdoor unit(s) is 18 gauge, two-conductor, twisted, stranded, shielded wire.	
Master / slave communication bus: SODU A and B terminals on master outdoor unit connected to SODU A and B terminals on slave outdoor unit(s).	
The shield is grounded to the chassis at the master outdoor unit only.	
There are ring or fork terminals at all control cable terminations.	
Shield is NOT terminated on outdoor unit main PCB "GND terminal". Shield is grounded to chassis of master outdoor unit.	
Maximum length of master / slave outdoor unit communication bus <3,280 feet	

Outdoor Unit to Indoor Unit / Heat Recovery Unit Communication Wiring

Description	Check		
Outdoor unit / Indoor unit communications cable are connected to terminals 3[A] and 4[B].			
Communications cable between the Master ODU and indoor units was connected in a daisy chain configuration (i.e., single parallel chain). No "star" or multiple parallel circuits. No cable splices or wire nuts were used to connect communications cables.			
Record Communication Voltage Range			
<table border="1" style="width: 100%; border-collapse: collapse;"> <tr> <td style="width: 50%;">High ----- VDC</td> <td style="width: 50%;">Low ----- VDC</td> </tr> </table>	High ----- VDC	Low ----- VDC	
High ----- VDC	Low ----- VDC		
All communications cables are a minimum of 18-gauge, two-conductor, twisted, stranded, shielded wire, with insulation material per local code. Cable segment shields were tied together. Cable shield is grounded at the master outdoor unit only.			
Low voltage control cables are properly secured to the control panel case. Terminal block screws are tight and the cable is protected from sharp edges at control box case and conduit openings.			
There are ring or fork terminals at all control cable terminations.			
Cables are installed at recommended distances from high voltage and EMF generating equipment.			
All power and control wires were properly separated using the recommended distance provided in the product installation manual.			
If required, communications cable is plenum rated.			
Maximum length of indoor unit communication bus: <3,280 feet			

Installation Checklist, continued

Indoor Unit to Wired Remote (Zone) Controller Wiring

Description	Check
There are ring or fork terminals at all control cable terminations where possible.	
Communication cable from indoor units to wired remote (zone) controllers is a 33' connection cable (included with the controllers); or, if terminals are present, 22-gauge, three-conductor, twisted, stranded, unshielded wire. No cables were spliced and no wire nuts are present.	
Where appropriate LG-supplied Y-cables and extension cables were used between indoor units.	
Zone controller cable is securely plugged into the CN-REMO socket on the indoor unit circuit board if LG supplied connection cable has been used.	
Cable is securely attached to the socket on the zone controller or the three screw terminals (controller model specific); Yellow to "Y", Red to "R", and Black to "B".	
If an optional remote temperature sensor was installed, the associated cable is plugged into socket CN-ROOM (the factory return air thermistor has been unplugged).	
If a gravity drain primary condensate system is used (condensate pipe ONLY connected to the lowest nipple) the CN-D / Pump plug has been removed from the socket on the control board (High-Static models only).	
All plugs are properly seated in the sockets on the control board.	
Maximum length of wire from Indoor Unit to Wired Remote Controller < 164 feet.	

Outdoor Unit Central Communication Bus Wiring

Description	Check
Central Control Communication Bus: CEN A and B terminals on master outdoor unit to CH1, CH2, CH3, or CH4 terminals A and B on central controllers (See specific central controller Install Manual for appropriate channels).	
Devices on central control communication bus (ex. PI-485) are connected to appropriate terminals on device (See specific Device Install Manual for appropriate terminal information).	
Record Communication Voltage Range <div style="border: 1px solid black; padding: 2px; width: fit-content;"> High _____ VDC Low _____ VDC </div>	
All communications cables are a minimum of 18-gauge, two-conductor, twisted, stranded, shielded wire with insulation material per local code. Cable segment shields were tied together. Cable shield is grounded at the master outdoor unit only.	
Low voltage control cables are properly secured to the control panel case. Terminal block screws are tight and the cable is protected from sharp edges at control box case and conduit openings.	
There are ring or fork terminals at all control cable terminations.	
Cables are installed at recommended distances from high voltage and EMF generating equipment.	
All power and control wires were properly separated using the recommended distance provided in the product installation manual.	
If required communications cable is plenum rated.	
Maximum length of central communication bus < 3,280 feet	

Outdoor Unit Configuration

Description	Check
Is the outdoor unit a Multi V IV?	
Has the outdoor unit been configured to operate with Gen 4 indoor unit features?	
Is the outdoor unit a Multi V 5?	
If the outdoor unit is a Multi V 5, has the outdoor unit been configured as a Heat Pump (if designed as a Heat Pump system)?	
If the outdoor unit is a Multi V 5 and has been configured as a Heat Pump, has it been piped correctly (No piping connected to the traditional suction pipe)?	
In a dual / triple frame system, one (1) outdoor unit must be set to master and the others set to slave(s) or an error code will be generated.	
Are all outdoor unit DIP switch settings correct?	

Indoor Unit / Heat Recovery Unit Configuration

Description	Check
Auto addressing: All indoor units and heat recovery units have been found and no errors codes have appeared.	
If indoor units will be centrally controlled, has an addressing schedule been created?	
Indoor unit under central control: Manually set (through the remote controller) and each indoor unit with a two-character hexadecimal address: 0-9 and A-F (⊙ do not use Address "00"). ⊙ Do not duplicate addresses even if they are on separate systems.	
Indoor unit DIP switches have been adjusted for chosen applications (group control-master / slave; continuous fan operation; dry contact).	
All heat recovery unit DIP switches and rotary dial settings are correctly set.	
Zone controller DIP switches and / or settings have been adjusted for the application's space temperature sensing strategy.	